

t: +(27) 011 468 1881 c: +(27) 074 465 1744
 e: 01@BirCraft.co.za w: www.BirCraft.co.za

DC Washdown Motors

BADCWDM-11

Applications:

- ✓ Food Processing Conveyors
- ✓ Feeders

Features:

- ✓ Moisture sealant on bolt heads between frame and endplates
- ✓ Neoprene gasketed conduit box
- ✓ Double sealed bearings
- ✓ Forsheda® running contact V-Ring slinger
- ✓ Stainless steel shaft
- ✓ Class F Insulation
- ✓ Tachometer adaptable
- ✓ Suitable for high pressure washdown



Motor:

TYPE:	INFORMATION:	TYPE:	INFORMATION:
ARMATURE VOLTAGE:	180 V	AMBIENT TEMPERATURE:	40 °C
BASE SPEED:	1750 RPM	ARMATURE CURRENT:	7.7 A
ENCLOSURE:	TEFC	SHAFT ROTATION:	Reversible
FRAME:	145TC	DUTY:	S1
FRAME MATERIAL:	Steel	WEIGHT:	29.03KG

Drawing:

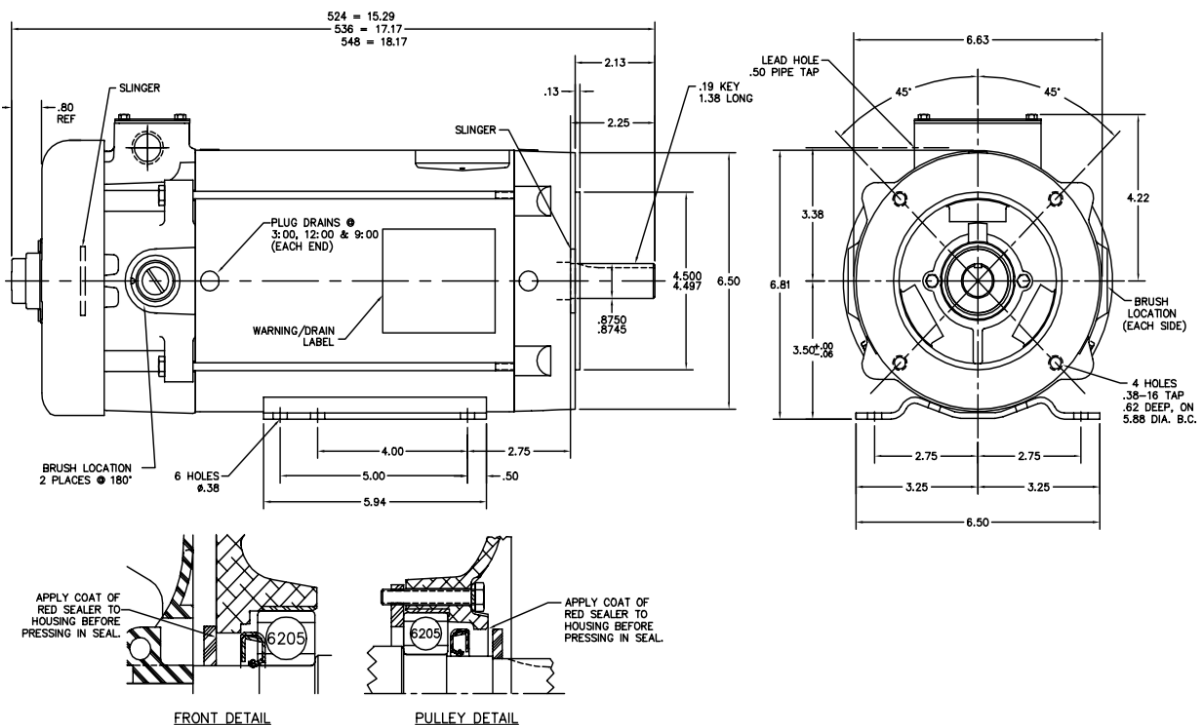

MOTOR

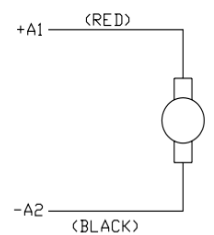

THEROMSTAT (WHEN REQUIRED)

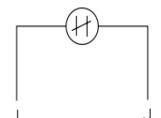

TACHOMETER

